



REF.
DATE

For each item select the request option

5

MIDI.40_adj_TL_snap in_on board

FOLIO®

Product type	Quantity	<input type="checkbox"/> 1 CCT	<input type="checkbox"/> 2 Lens	<input type="checkbox"/> 3 Dimmerability	<input type="checkbox"/> 4 Aluminum finish	<input type="checkbox"/> 5 Accessories
MIDI.40						

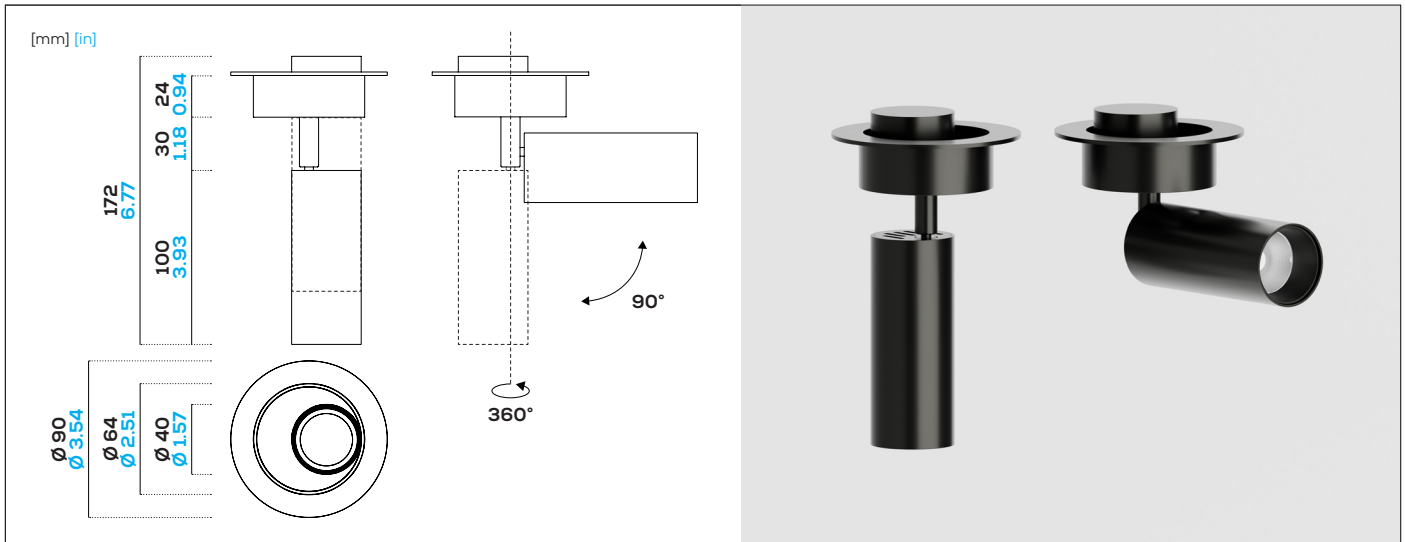

GENERAL SPECS.

Weight:	0,31 kg
Movement:	Adjustable: 360° rotation, 0-90° tilt
IP:	20

The Spot.Mate system is a highly versatile range of spotlights, designed to meet the most diverse architectural and lighting needs. Available in four sizes, the spotlights can be installed on various surfaces, offering multiple features and movement possibilities. Each product is entirely customizable in various aspects to perfectly suit any specific project.



LIGHT SOURCE

LED type:	Nichia
LED Amperage:	500 mA
LED Duration:	50 000 h.
Power:	6.1 W
Delivered Lumen:	650 lm
Efficacy:	106.5 lm/W
Candela:	
CRI:	> 90
R9:	> 50
TM30:	Rf: 91 Rg: 100
SDCM:	2
Color Temperature (CCT):	<input type="checkbox"/> 2700K <input type="checkbox"/> 3000K <input type="checkbox"/> 3500K <input type="checkbox"/> 4000K <input type="checkbox"/> on request: 2000K, 2200K, 2500K, 5000K

OPTICS

Optic Type:	lens
Beam Angle (BA°)	<input type="checkbox"/> 12° <input type="checkbox"/> 19° <input type="checkbox"/> 25° <input type="checkbox"/> costum on request

ELECTRICAL

Voltage:	24V DC (Constant Voltage)
Class:	Class 3 24V
Driver:	DC/DC 24 V
Output current:	500 mA
Dimmerability:	<input type="checkbox"/> 0-10 V <input type="checkbox"/> 1-10 V <input type="checkbox"/> DALI <input type="checkbox"/> DMX <input type="checkbox"/> Bluetooth <input type="checkbox"/> PUSH

Images / 3D / sections and the relative details shown in the following pages are generic and indicative. The number and position of the fixing points and fasteners may change during the production phase. The type, quantity and position of the Folio panels' power cables are indicative.



REF.
DATE

For each item select the request option

MIDI.40_adj_TL_snap in_on board



Product type	Quantity	<input type="checkbox"/> 1 CCT	<input type="checkbox"/> 2 Lens	<input type="checkbox"/> 3 Dimmerability	<input type="checkbox"/> 4 Aluminum finish	<input type="checkbox"/> 5 Accessories
MIDI.40						

ALUMINIUM FINISHES

4

RAL/NCS/Pantone:

Polished finish:



Brushed finish:

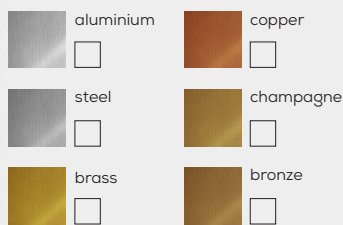

Galvanic finish:

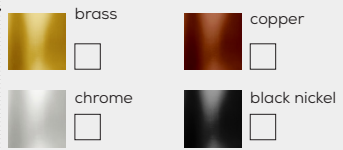

ACCESSORIES

5

Honeycomb

Snoot



LENS INFO

Beam Angle (BA°): 12°

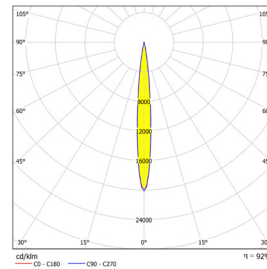

Beam Angle (BA°): 19°

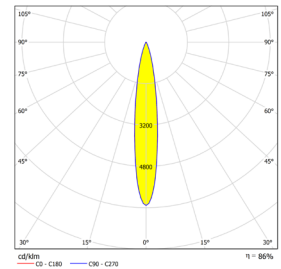

Beam Angle (BA°): 25°

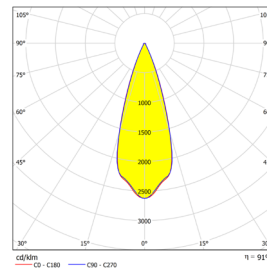

APPLICATIONS

Folio Opal*

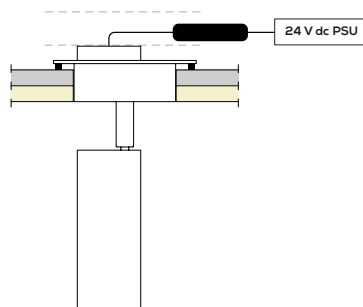

Cut out: \varnothing 54 mm / \varnothing 2.12 in



Clear volume: 20mm / 0.78 in

Other Material Application

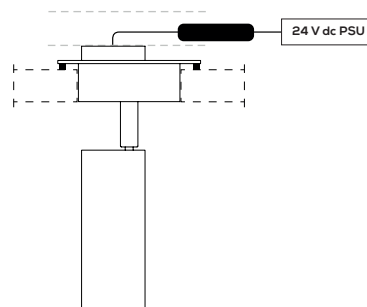

Cut out: \varnothing 54 mm / \varnothing 2.12 in



Clear volume: 20mm / 0.78 in

*The fixture is supplied fully assembled and does not require additional mounting of the light source.

Images / 3D / sections and the relative details shown in the following pages are generic and indicative. The number and position of the fixing points and fasteners may change during the production phase. The type, quantity and position of the Folio panels' power cables are indicative.



REF.
DATE

For each item select the request option

MIDI.40_adj_TL_snap in_on board



Product type	Quantity	1 CCT	2 Lens	3 Dimmerability	4 Aluminum finish	5 Accessories
MIDI.40						

FEATURES

360° rotation, 0-90° tilt

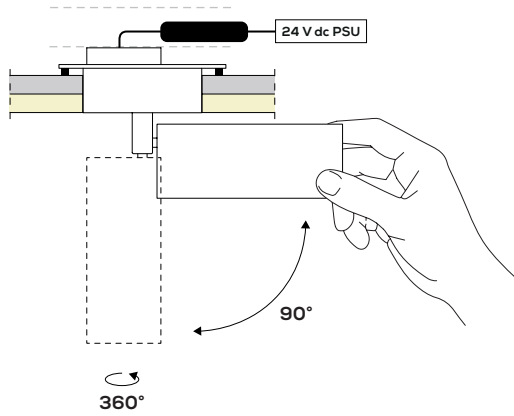

Snap in - Snap out

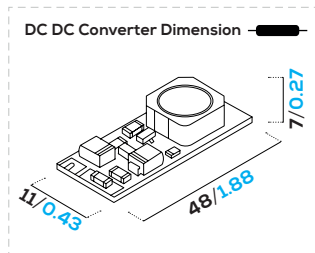
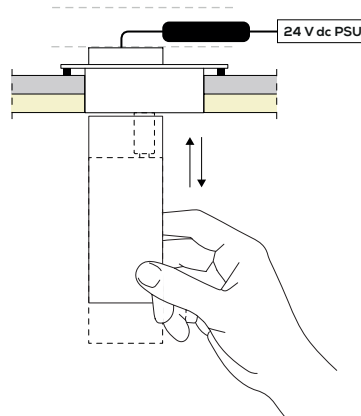

Images / 3D / sections and the relative details shown in the following pages are generic and indicative. The number and position of the fixing points and fasteners may change during the production phase. The type, quantity and position of the Folio panels' power cables are indicative.