



REF.  
DATE

For each item select the request option

20

# LIGHT.26\_adj\_TL\_plug in\_on board



Product type	Quantity	1 CCT	2 Lens	3 Dimmerability	4 Aluminum finish	5 Accessories
LIGHT.26						

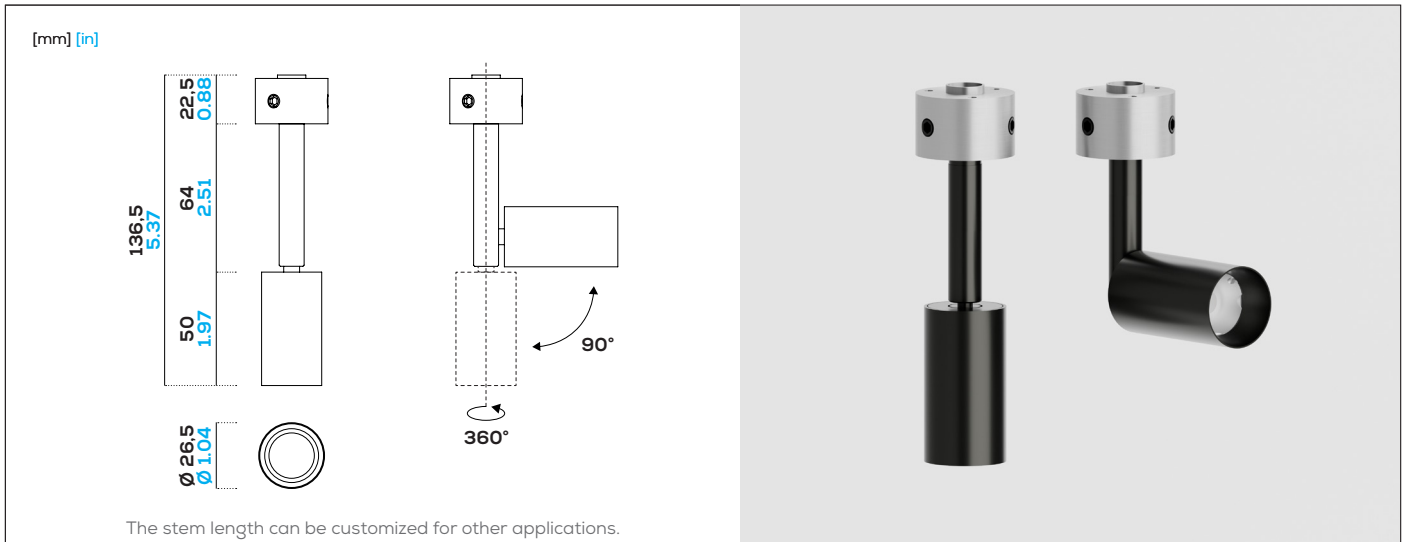

## GENERAL SPECS.

Weight:	0,14 kg
Movement:	Adjustable: 360° rotation, 0-90° tilt
IP:	20

The Spot.Mate system is a highly versatile range of spotlights, designed to meet the most diverse architectural and lighting needs. Available in four sizes, the spotlights can be installed on various surfaces, offering multiple features and movement possibilities. Each product is entirely customizable in various aspects to perfectly suit any specific project.



## LIGHT SOURCE

LED type:	Nichia
LED Amperage:	700 mA
LED Duration:	50 000 h.
Power:	2.1 W
Delivered Lumen:	220 lm
Efficacy:	104.8 lm/W
Candela:	
CRI:	> 90
R9:	> 50
TM30:	Rf: 91 Rg: 100
SDCM:	3
Color Temperature (CCT):	<input type="checkbox"/> 2700K <input type="checkbox"/> 3000K <input type="checkbox"/> 3500K <input type="checkbox"/> 4000K <input type="checkbox"/> on request: 2000K, 2200K, 2500K, 5000K

## OPTICS

Optic Type:	lens
Beam Angle (BA°)	<input type="checkbox"/> 12° <input checked="" type="checkbox"/> 18° <input type="checkbox"/> costum on request

## ELECTRICAL

Voltage:	24V DC (Constant Voltage)
Class:	Class 3 24V
Driver:	DC/DC 24 V
Output current:	700 mA
Dimmerability:	<input type="checkbox"/> 0-10 V <input type="checkbox"/> 1-10 V <input type="checkbox"/> DALI <input type="checkbox"/> DMX <input type="checkbox"/> Bluetooth <input type="checkbox"/> PUSH

Images / 3D / sections and the relative details shown in the following pages are generic and indicative. The number and position of the fixing points and fasteners may change during the production phase. The type, quantity and position of the Folio panels' power cables are indicative.



REF.  
DATE

For each item select the request option

# LIGHT.26\_adj\_TL\_plug in\_on board



Product type	Quantity	<input type="checkbox"/> 1 CCT	<input type="checkbox"/> 2 Lens	<input type="checkbox"/> 3 Dimmerability	<input type="checkbox"/> 4 Aluminum finish	<input type="checkbox"/> 5 Accessories
LIGHT.26						

## ALUMINIUM FINISHES

4

RAL/NCS/Pantone:

Polished finish:

<input type="checkbox"/>	aluminium	<input type="checkbox"/>	copper
<input type="checkbox"/>	steel	<input type="checkbox"/>	champagne
<input type="checkbox"/>	brass	<input type="checkbox"/>	bronze

Brushed finish:

<input type="checkbox"/>	aluminium	<input type="checkbox"/>	copper
<input type="checkbox"/>	steel	<input type="checkbox"/>	champagne
<input type="checkbox"/>	brass	<input type="checkbox"/>	bronze

Galvanic finish:

<input type="checkbox"/>	brass	<input type="checkbox"/>	copper
<input type="checkbox"/>	chrome	<input type="checkbox"/>	black nickel

## ACCESSORIES

5

Honeycomb

Snoot



## LENS INFO

Beam Angle (BA°): 12°

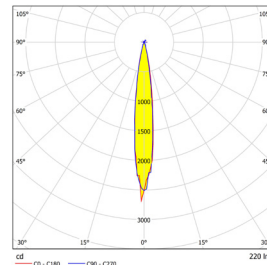

Beam Angle (BA°): 18°

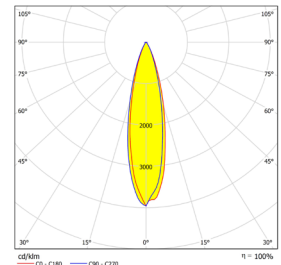

## APPLICATIONS

Folio Opal

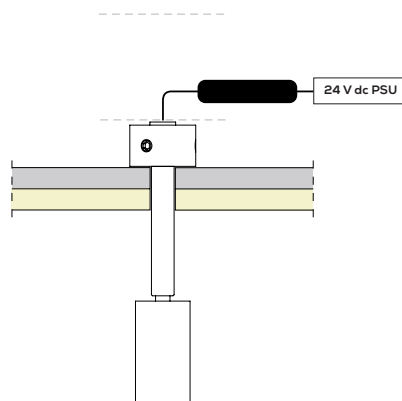

Cut out:  $\varnothing$  11,5 mm /  $\varnothing$  0.45 in



Clear volume: 50 mm / 1.96 in

Folio Zero

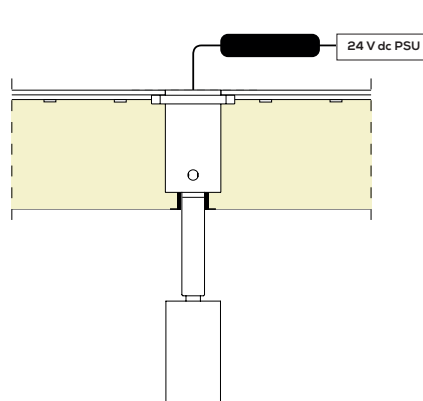

Cut out:  $\varnothing$  11,5 mm /  $\varnothing$  0.45 in



Clear volume: 50 mm / 1.96 in

Other Material Application

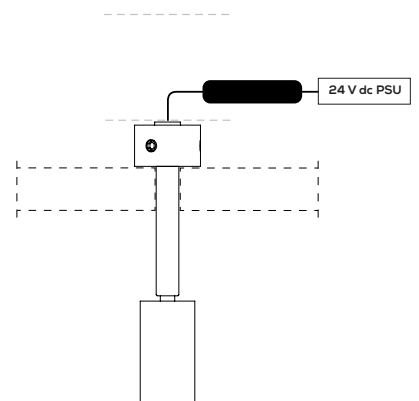

Cut out:  $\varnothing$  11,5 mm /  $\varnothing$  0.45 in



Clear volume: 50 mm / 1.96 in

\*The fixture is supplied fully assembled and does not require additional mounting of the light source.

Images / 3D / sections and the relative details shown in the following pages are generic and indicative. The number and position of the fixing points and fasteners may change during the production phase. The type, quantity and position of the Folio panels' power cables are indicative.



# LIGHT.26\_adj\_TL\_plug in\_on board



Product type	Quantity	1 CCT	2 Lens	3 Dimmerability	4 Aluminum finish	5 Accessories
LIGHT.26						

## MOUNTING INSTRUCTION

### STEP 1: Ready to install

Folio Opal supplied with integrated mounting sleeve and pre-cut hole.

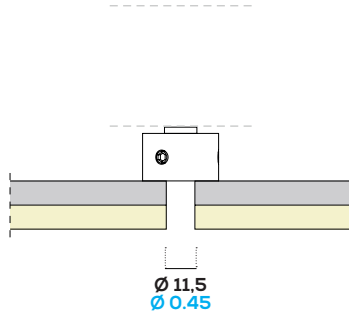

### STEP 2:

Pull the 24V cable through the opening for external connection.

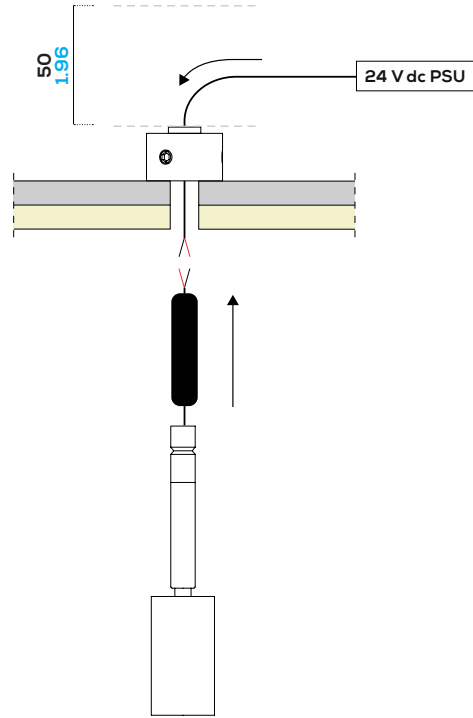

### STEP 3:

Connect the spot to the power supply.

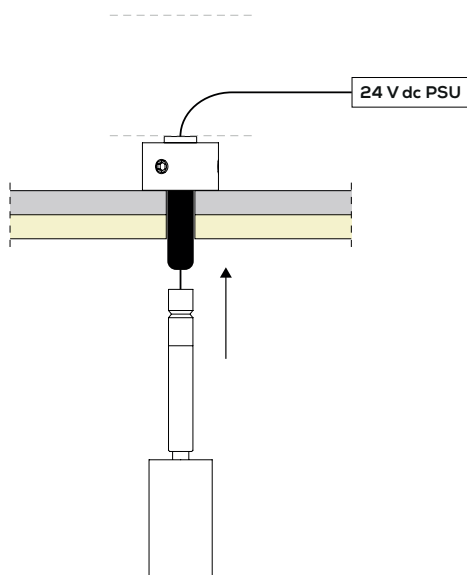

### STEP 4: Installation

Insert the spot into the sleeve until it clicks into place.

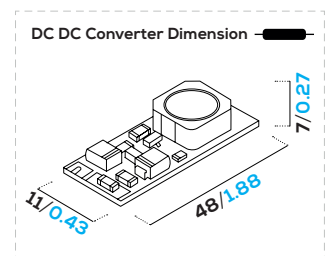
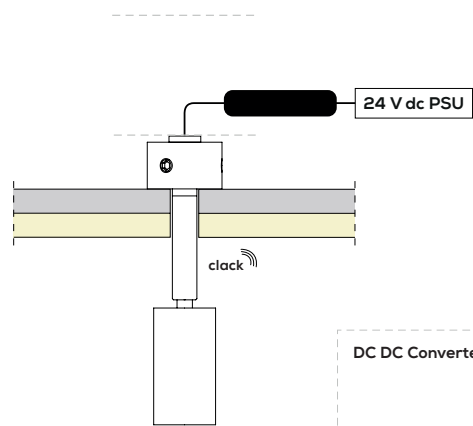

Images / 3D / sections and the relative details shown in the following pages are generic and indicative. The number and position of the fixing points and fasteners may change during the production phase. The type, quantity and position of the Folio panels' power cables are indicative.



# LIGHT.26\_adj\_TL\_plug in\_on board



Product type	Quantity	1 CCT	2 Lens	3 Dimmerability	4 Aluminum finish	5 Accessories
LIGHT.26						

## STEP 5:

Insert the spotlight until you hear a click.  
The spotlight is now ready for use.

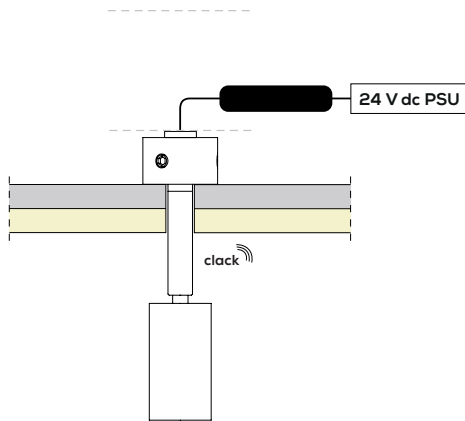

## FEATURES

360° rotation \_ 0-90° tilt

Plug in - Plug out

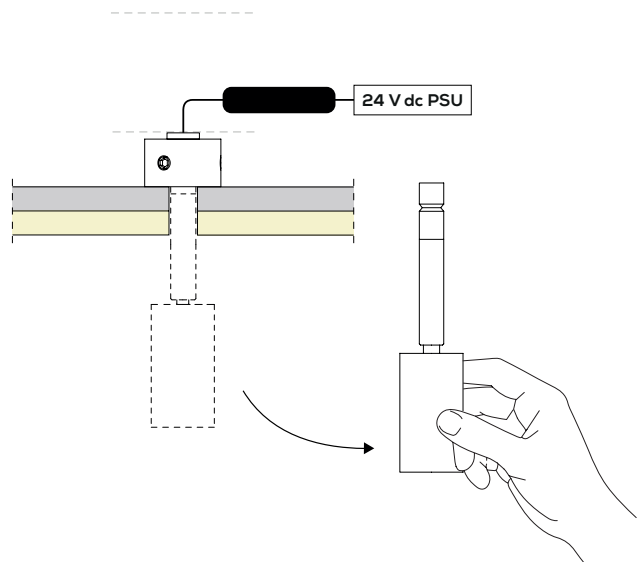
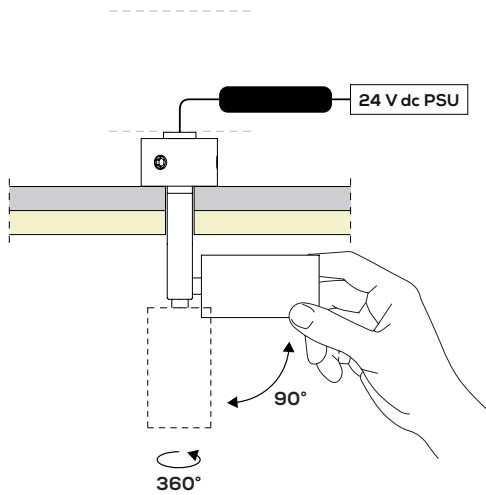

*Images / 3D / sections and the relative details shown in the following pages are generic and indicative. The number and position of the fixing points and fasteners may change during the production phase. The type, quantity and position of the Folio panels' power cables are indicative.*