



REF.



Per ogni voce selezionare l'opzione scelta
For each item select the chosen option

1

.RING

FOLIO®

Q.ty	Product type	Sizes	LED position	CCT	Al finish	Op finish	Fixing	Type Spot.Mate	Al finish Spot.Mate	CCT Spot.Mate	Lens Spot.Mate	Cable length	Warranty	Dimm.	LED type	IP Rating
		50 500						26.a								

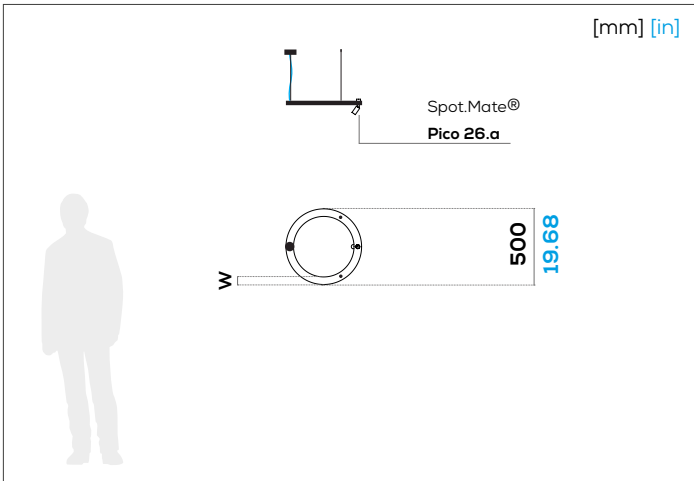

W 50 W 1.97
 ø 500 mm ø 19.68 in

Altre dimensioni disponibili.
Custom size available.

INSTALLATION

Standard a sospensione
Suspended standard

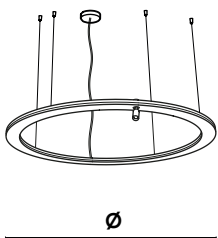

Speciale a sospensione
Suspended special

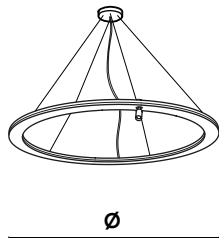

Il numero e la posizione dei cavi di sospensione e delle cover nel disegno sono indicativi.

The number and the position of the suspension cables and coverplates in the drawing are indicative.

APPLICATIONS



TECHNICAL DESCRIPTION

RING è la nuova serie di prodotti Folio a geometria circolare con diametri definiti tra **500 mm e 1100 mm** e larghezza tra 50 mm e 70 mm. Omogeneità luminosa garantita dal diffusore opale con spessore 10 mm e dalla lastra interna in metacrilato incisa a laser con tecnologia edge lighting. RING è dotato da 1 a 3 Folio Spot.Mate® Pico 26.a a posizione variabile. Protezione esterna con scocca in alluminio per favorire la rigidità e la dissipazione del calore. LED Nichia ad alta efficienza energetica, dimmerabili 0-10 V, 1-10 V, DALI, DMX, Bluetooth, Push. Disponibile nelle versioni con alimentatore remoto o con alimentatore integrato.

RING is the new series of Folio products of circular form with defined diameters between 500 mm and 1100 mm and widths between 50 mm and 70 mm. Homogeneous luminosity is guaranteed by the opal diffuser with a thickness of 10 mm. The internal methacrylate plate is laser engraved with lighting edge technology. RING is equipped with 1/3 Folio Spot.Mate® Pico 26.a adjustable. The external protection made of an aluminum shell favours rigidity and heat dissipation. The Nichia LEDs with high energy efficiency, are dimmable 0-10 V, 1-10 V, DALI, DMX, Bluetooth, Push. Available either with remote or integrated power supply.

STANDARD CERTIFICATIONS



LIGHTING ACCESSORIES



POLAR DIAGRAM

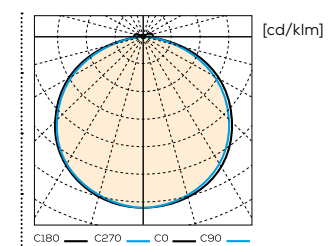



REF.

Per ogni voce selezionare l'opzione scelta
For each item select the chosen option

2

.RING**FOLIO®**

Q.ty	Product type	Sizes	LED position	CCT	Al finish	Op finish	Fixing	Type Spot.Mate	Al finish Spot.Mate	CCT Spot.Mate	Lens Spot.Mate	Cable length	Warranty	Dimm.	LED type	IP Rating
		50 500						26.a								

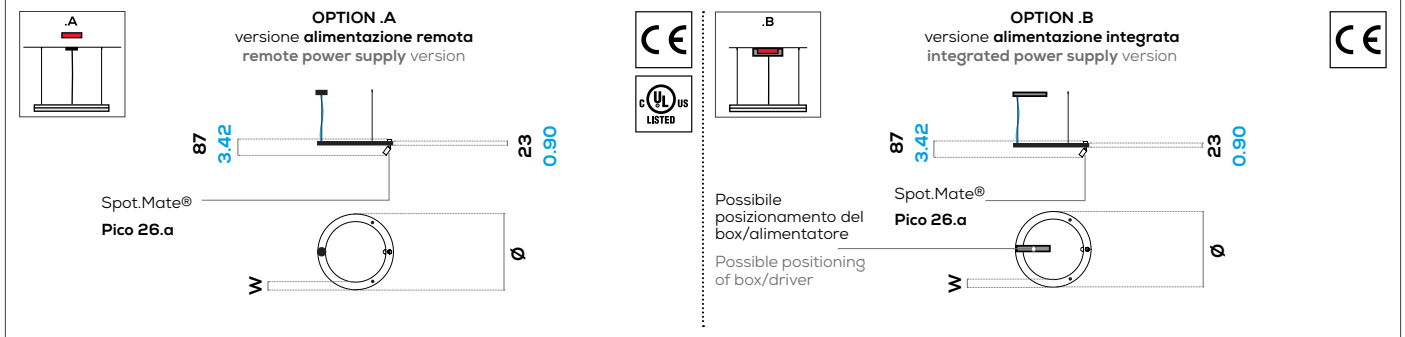
QUANTITÀ
QUANTITIESW 50
ø 500 mmW 1.97
ø 19.68 in

PHYSICAL SPECS.

Tipologia di prodotto:
Product type:

RI.A Versione con **alimentazione remota**
(alimentatore non incluso)
Remote power supply version
(power supply not included)



RI.B Versione con **alimentazione integrata**
(alimentatore non incluso)
Integrated power supply version
(power supply not included)

Spessore:
Thickness:23 mm
0.90 in

(*) Spot.Mate® Pico 26.a

87 mm (*)
3.42 inPeso:
Weight:3 kg
6.61 lbMateriali:
Materials:Alluminio - Metacrilato - LED
Aluminum - Methacrylate - LEDDimensioni:
Sizes:50 mm
1.97 in500 mm
18.89 in26 mm (*)
1.02 in

(*) Spot.Mate® Pico 26.a

Cavi di sospensione:
Suspension cables:

3

Lunghezza cavi sosp.
Cable susp. length:3 Standard: 3000 mm
Standard: 118.11 in5 5000 mm (su richiesta)
196.86 in (on request)Cover cavo alimentazione:
Power cable coverplate:Tonda
Round

GENERAL SPECS.

Installazione:
Fixing:

S Standard a sospensione
Suspended standard



U Speciale a sospensione
Suspended special

Ambiente di utilizzo:
Environment of use:Interno
IndoorDurata LED:
LED lifespan:L90 > 60.000 ore a 50° Celsius
L90 > 60.000 hours at 50° CelsiusBlue light risk group:
Blue light risk group:EXEMPT UNLIMITED (200 mm)
EXEMPT UNLIMITED (7.87 in)Garanzia:
Warranty:

2Y 2 anni
2 years



5Y Su richiesta estensione fino a 5 anni
On request extension up to 5 years

FINISHES

Finiture alluminio:
Aluminum finishes:

W bianco
white



B nero
black



S speciale (verniciatura o ossidazione)
special (liquid painting or oxidation)

Finiture
Spot.Mate® Pico 26.a:
Spot.Mate® Pico 26.a
finishes:

B nero
black



S speciale (verniciatura o ossidazione)
special (liquid painting or oxidation)



REF.

Per ogni voce selezionare l'opzione scelta
For each item select the chosen option

3

.RING

FOLIO®

Q.ty	Product type	Sizes	LED position	CCT	Al finish	Op finish	Fixing	Type Spot.Mate	Al finish Spot.Mate	CCT Spot.Mate	Lens Spot.Mate	Cable length	Warranty	Dimm.	LED type	IP Rating
		50 500						26.a								

Finiture diffusore:

Diffuser finishes:

(*) Finiture speciali su richiesta

(*) Special finishes on request

- M** opale opaco
matte opal
- G** opale lucido
glossy opal
- OM** Opale Milling - fresato (*)
Opal Milling - milled
- OS** Opale Sculpture - inciso a laser (*)
Opal Sculpture - laser engrave
- OP** opale stampato (*)
printed opal
- OF** opale con pellicola stampata (*)
opal with printed film

Posizione LED:

LED position:

- P1** Perimetro
Perimeter

Consumo:

Consumption:

(*) Spot.Mate® Pico 26.a

P1 40 W

2,1 W @ 700 mA (*)

Flusso luminoso output:

Luminous flux output:

(*) Spot.Mate® Pico 26.a

P1 865 lm

220 lm (*)

ELECTRICAL SPECS.

Voltaggio:

Voltage:

24V DC

Driver - alimentatore:

Driver - power supply:

AC/DC 24V

Dimmerabilità:

Dimmability:

- 010** 0-10V
- 110** 1-10V
- DA** DALI
- DM** DMX
- BL** Bluetooth
- PH** PUSH

Lenti

Spot.Mate® Pico 26.a:

Lens

Spot.Mate® Pico 26.a:

 12° **18°**

Indice di resa cromatica:

Color rendering index:

NStandard
CRI: Ra min. 90 - R9 min. 50**O**Su richiesta CRI: Ra = 100
(Nichia Optisolis™)
On request CRI: Ra = 100
(Nichia Optisolis™)

LED

Tipologia LED:

LED type:

- N** **NICHIA 757 R9050**
- O** Nichia Optisolis™ (su richiesta)
Nichia Optisolis™ (on request)
- V** Nichia Vitasolis™ (su richiesta)
Nichia Vitasolis™ (on request)

Grado di protezione:

IP rating:

 40 Standard:**IP40** **54**IP54 (su richiesta)
IP54 (on request) **DL**Damp Location (su richiesta)
Damp Location (on request)

Tipologia LED

Spot.Mate® Pico 26.a:

Spot.Mate® Pico 26.a

LED type:

NICHIA**UGR**

Indici di riflessione:

Reflectance indexes:

UGR

RING:

UGR

Spot.Mate® Pico 26.a:

X = 4H, Y = 8H, S = 0,25H
70/ 50/ 20

<19

<19



REF.



Per ogni voce selezionare l'opzione scelta
For each item select the chosen option

4

.RING











Q.ty	Product type	Sizes	LED position	CCT	Al finish	Op finish	Fixing	Type Spot.Mate	Al finish Spot.Mate	CCT Spot.Mate	Lens Spot.Mate	Cable length	Warranty	Dimm.	LED type	IP Rating		
		50 500						26.a										

Temp. colore (CCT):

Color temp. (CCT):

(*) Lo spessore del pannello varia con CCT dinamici

(*) Panel thickness changes with dynamic CCT

- 27  2700K
- 30  3000K
- 35  3500K
- 40  4000K
- 57  5700K
- TW  Tunable White (2700K - 5700K) (*)
- R  RGB (*)
- RW  RGBW (*)
- RTW  RGBTW (*)
- RQ *Su richiesta 2000K, 2200K, 2500K, 5000K, 6500K and TW custom (*)*
On request 2000K, 2200K, 2500K, 5000K, 6500K and custom TW

Temp. colore (CCT)

Spot.Mate® Pico 26.a

Spot.Mate® Pico 26.a

color temp (CCT):

- 27  2700K
- 30  3000K
- 35  3500K
- RQ *Su richiesta 2000K, 2200K, 2500K, 4000K, 5000K*
On request 2000K, 2200K, 2500K, 4000K, 5000K